



HiTi P720L Photo Printer

Boost Your Photo Printing Business
Productivity and Profitability



High Media Capacity



Multiple Applications



HiTi Professional Software



► Powerful Performance & Incredible Efficiency

Built from guiding principle, HiTi P720L was designed to maximize your photofinishing profits by increasing uptime, shortening printing time, and providing multi-applications. HiTi P720L is recommended to use with HiTi Picvite Suite, which is easy and with less investment to create your highly scalable and profitable photofinishing business.



Shortening Printing Time

Roll-fed mechanism design with HiTi outstanding printing technology gets 4"x6" (10x15cm) prints within 7.9 seconds*

* Under the conditions of HiTi laboratory testing.

Increasing Uptime

By 1000-print capacity design, HiTi P720L is much less often in changing media, and gives more selling time. Also, high capacity roll reduces staff interruption.



Fitting in Multi-Applications

With full front-access design, HiTi P720L can be integrated in unattended or semi-attended Kiosk system at retail. With HiTi Picvite Suite, HiTi P720L, as a micro mass photofinishing system, is capable of competing against silver halide.



► Superior Printing Performance

Powered by HiTi Color

With HiTi Color Technology inside, HiTi P720L is the preferred brand of photo printers by many photo and imaging professionals as well as enthusiasts around the world.



Hassle-free Operation

By straightforward instruction, getting HiTi P720L ready is not laborious any more.

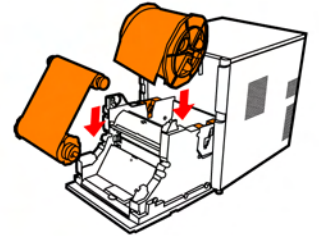

Color Optimization

HiTi Color Technology offers two color preferences for different printout request. **HiTi Passport Photo Color** produces superior skin tones in portrait; **HiTi Classic Color** provides brilliant life-like true color reproduction for your digital images.



Prime Quality in Matte Finish

Apart from glossy photos, HiTi P720L is capable of matte finish. No media change required!

Diverse Print Formats

HiTi P720L allows most diversity in print sizes, including 4"x6", 4"x6"-2UP, 5"x7", 5"x7"-2UP, 6"x8", 6"x9" and 6"x9"-2UP*.

*2UP function should be operated from printer driver.

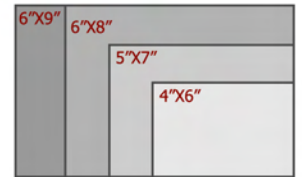

Appearance

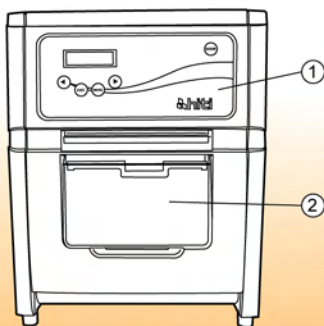

<Front View>

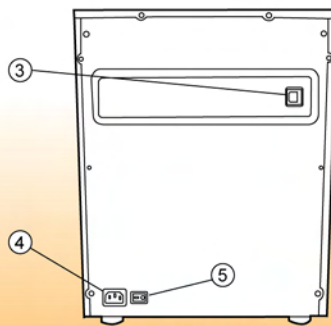

<Rear View>

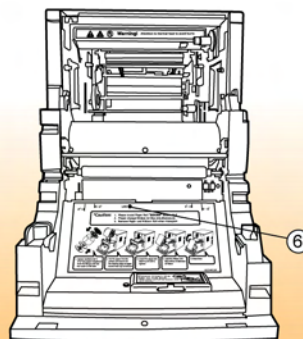

<Internal View>

- ① Operation Panel
- ② Waste Paper Box
- ③ USB Connector
- ④ Power Connector
- ⑤ Power Switch
- ⑥ Paper Setting Indicator

▶ Professional Software Improving Working Efficiency from Input to Output

HiTi Picvite Suite consists of Picvite Kiosk (express) and Picvite Minilab (express) built with friendly user interface creating memorable printing experience for both retail customers and studio owners.

HiTi Picvite Kiosk (Express) Software

HiTi Picvite Kiosk (express) provides a platform for front-end operation where it takes the most photofinishing orders, and a fully functional administration system for back-end management.

- Slide touch technology at front stage
- Complete backstage management functions
- Sales data export for accounting purposes



◆ HiTi Picvite Kiosk (Express)



HiTi Picvite Minilab (Express) Software

To increase working efficiency at photo shops, HiTi Picvite Minilab (Express) offers powerful tools for shop owners to efficiently handle mass print orders, quickly process digital images, and real time monitor printer status.

- Printing order management
- Integration of inventory & accounting system
- Cash flow control from front desk
- Powerful image adjustment tools

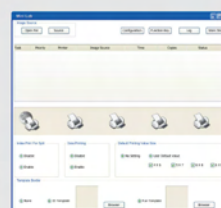

◆ HiTi Picvite Minilab (Express)



▶ Upgrading Photofinishing Business

Instant Photo Business

HiTi P720L was designed specifically for instant printing thru exclusive HiTi Picvite Suite portfolio. It produces 4"x6" (10x15cm) with optimal quality within just 7.9 seconds.



Less Input but Most Output

HiTi P720L can be integrated with HiTi P510K printer to turn into an express kiosk system producing from 4"x6" (10x15cm) to 6"x9" (15x23cm) with fun and creative options.



Diverse Photofinishing Services

Dry minilab system is achievable thru the combination of HiTi P720L and HiTi Picvite Suite application. Lightning-fast printing speed with longer uptime and varied image input gateway via exclusive HiTi Picvite Suite enable shop owner to provide the most printing services.

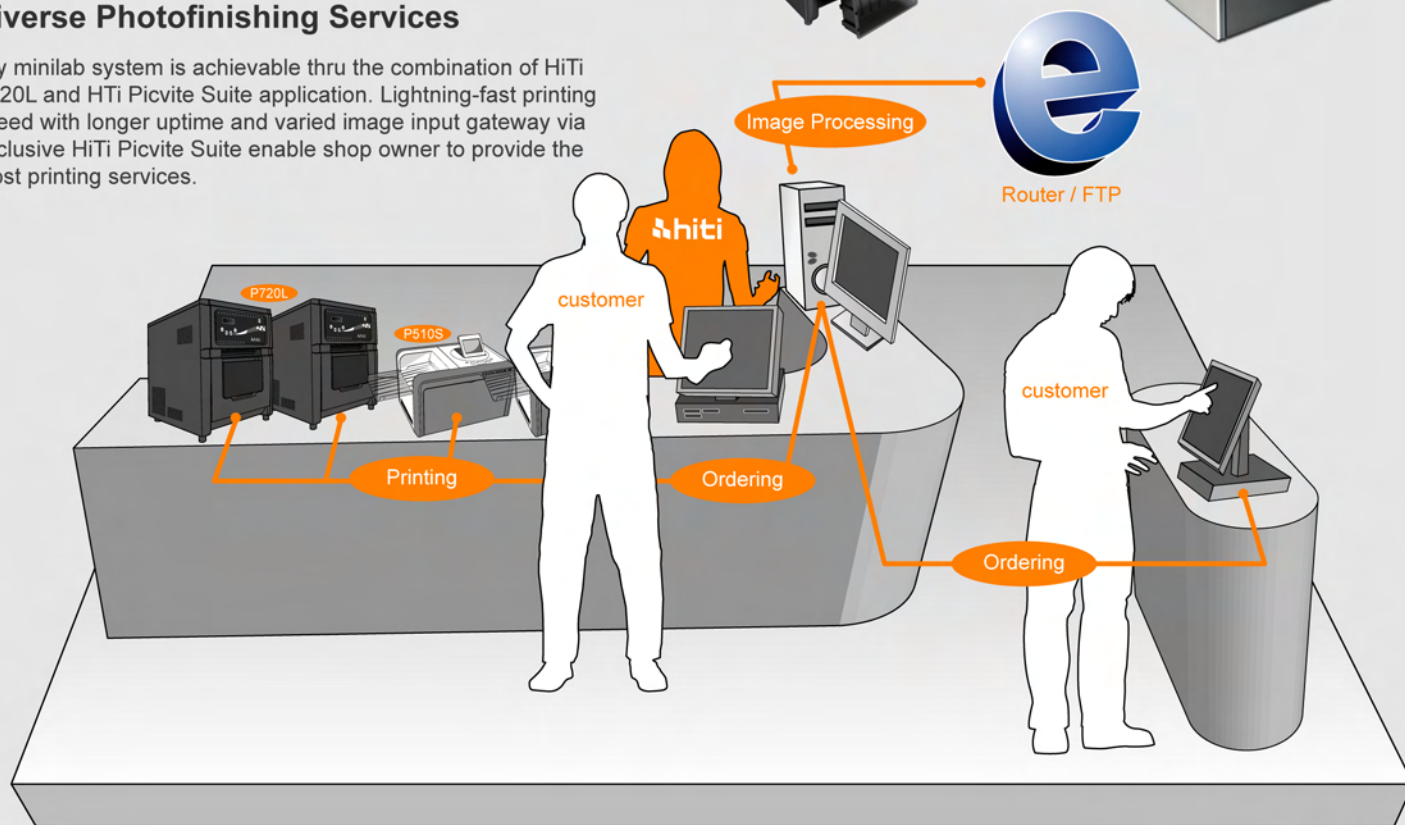

► Specifications

Model Name	HiTi P720L
Printing Method	Dye Diffusion Thermal Transfer (D2T2 Technology)
Resolution	300 x 300 dpi
Printing Size & Capacity*	4"x 6" (102 x 152 mm): 1000 prints 5"x 7" (127 x 177 mm): 600 prints 6"x 8" (152 x 203 mm): 455 prints 6"x 9" (152 x 229 mm): 455 prints 4"x 6" -2UP 5"x 7" -2UP 6"x 9" -2UP
Printing Speed**	4"x 6" approx. 7.9 seconds 5"x 7" approx. 12 seconds 6"x 8" approx. 15 seconds 6"x 9" approx. 15 seconds
PC-Link Operation	Yes
Recommended Software	Picvite Kiosk (Express) Picvite Minilab (Express)
Operation System	Windows 2000/ XP/ Vista/ Windows 7 Mac OS 10.2, 10.3, 10.4, 10.5 and 10.6
PC Connection	USB 2.0 Hi Speed
Power Requirement	AC 100 V ~240 V, 50/ 60 Hz, 6 A
Operation Environment	10°C ~ 35°C (50°F ~ 95°F); 20 ~90% non-condensing
Power Consumption	Total power consumption: approx. 500W Standby power consumption: approx. 20W
Dimension (W x H x D)	330 x 424 x 425 mm (13x16.7x16.7 inches)
Weight	26.7 kg / 58.9 lbs (consumable excluded)

* 2UP function should be operated from printer driver.

** Under the conditions of HiTi laboratory testing.

► Dimension



Service & Support Centers

Taiwan (Headquarters)

HiTi Digital, Inc.
9F, No. 225, Sec. 3, Beixin Rd., Xindian City, Taipei County 231, Taiwan
Tel: +886-2-2912-6268
Fax: +886-2-2912-6118
www.hiti.com

China

HiTi Digital Suzhou, Inc.
No. 58, XinQing Road, Suzhou Industrial Park, JiangSu, China
Tel: +86-512-8717-1688
Fax: +86-512-6760-1186
www.hiti.com/cn

Europe · Russia

HiTi Digital Europe B.V.
Ekkersrijt 1331, 5652 AJ, Son en Breugel, The Netherlands
Tel: +31-40-2565166
Fax: +31-40-2903176 & +31-40-2903287
www.hiti.com

North America

HiTi Digital America, Inc.
727 Brea Canyon Rd. Suite#2 Walnut, CA 91789, USA
Tel: +1-909-594-0099
Fax: +1-909-598-0011
www.hiti.com/us

Latin America

HiTi Digital, Inc. (Mexico)
Agustín Gonzalez de Cossio No. 1-202 Col. Del Valle, C.P. 03100,
Mexico, D. F. Mexico
TEL: +52-55-50253671, +52-55-50253672
FAX: +52-55-11076206
www.hiti.com/latinamerica

Middle East · Africa

HiTi Digital, Inc. MEA
Office No. 1608, Indigo Icon Tower, JLT, Dubai - U.A.E.
Tel: +971-4-3674547
Fax: +971-4-3674221
www.hiti.com

► Consumables

P720 Series



4" x 6" Ribbon & Paper Case
(2000 images per case)
Ribbon (1000 sheets / roll) x 2
Paper (1000 sheets / roll) x 2

P720 Series



5" x 7" Ribbon & Paper Case
(1200 images per case)
Ribbon (600 sheets / roll) x 2
Paper (600 sheets / roll) x 2

P720 Series



6" x 9" Ribbon & Paper Case
(910 images per case)
Ribbon (455 sheets / roll) x 2
Paper (455 sheets / roll) x 2

India

HiTi Digital, Inc. (New Delhi Liaison Office)
401/402, 4th floor, 96, Siddharth Building Nehru Place, New Delhi 110019
Tel: +91-11-4180-8191
Fax: +91-11-4180-8193
www.hiti.com

 HiTi Digital, Inc.

- ▲ © 2010 HiTi Digital, Inc. All Rights Reserved.
- ▲ Microsoft Windows and Vista are trademarks of Microsoft Corporation.
- ▲ Mac OS is a trademark of Apple Inc. All other trade names and trademarks are property of their respective owners.
- ▲ Specifications are subject to change without prior notice.